

# MOD 102 GUITAR AMP KIT (K-MOD102-F)

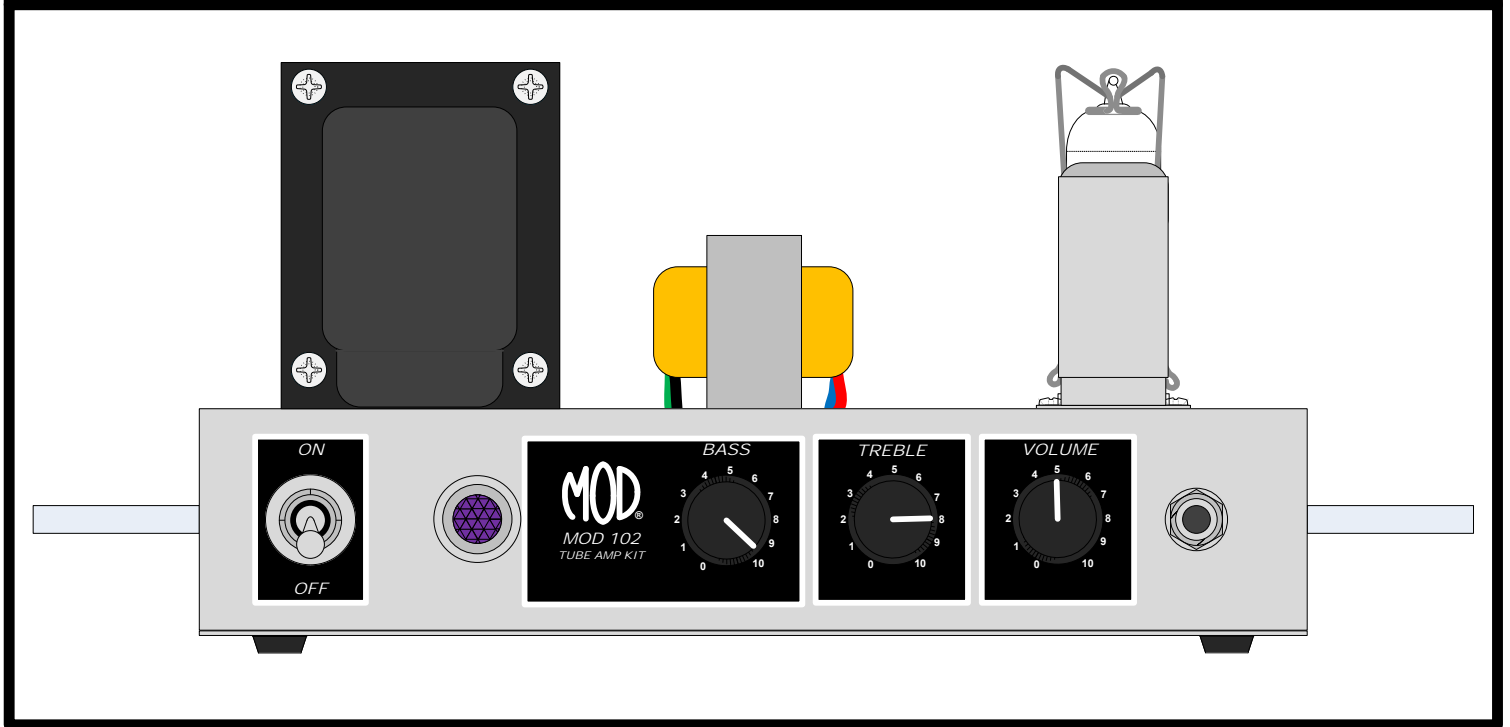

## Use these instructions to learn:

- How to build a tube amp.

This tube guitar amplifier circuit is based on a classic American circuit design combined with a British style class A output section. At low volume it produces a clean chimey tone that moves into smooth overdrive at higher volumes.

*The MOD102-F is the foreign (Non-USA) version of the MOD 102 including a Hammond 369EX world power transformer instead of the 269EX. Please note: **there is no power cord included with this kit** (due to variations in electrical outlets around the world). You will need to find a power cord that can fit through the 1/4" diameter (6.35 mm) rubber grommet hole on the rear panel.*

# MOD<sup>®</sup>

[www.modkitsdiy.com](http://www.modkitsdiy.com)

## **TABLE OF CONTENTS**

TOOL LIST .....	3
PARTS LIST .....	4
SAFETY .....	5
SOLDERING TIPS .....	6
WIRING TIPS .....	7
HARDWARE FASTENING TIP .....	8
STEP BY STEP ASSEMBLY INSTRUCTIONS .....	8
Section 1 - Mounting of Top Components .....	8
Section 2 - Mounting of Front Components .....	10
Section 3 - Mounting of Rear Components .....	11
Section 4 - Mounting Internal Terminal Strips and Passive Components .....	11
Section 5 - Connect Front Mounted Components .....	14
Section 6 - Connect Rear Mounted Components .....	14
Section 7 - Finish Connecting the Transformer and Power Supply Wires .....	15
Section 8 - Connect the Tube Filament Wiring .....	15
Section 9 - Finishing Up.....	16
Label Mounting Instructions .....	17

### **PARTS LIST DRAWINGS**           (4)

There are four parts list drawings separated from these instructions to help you find and identify each part.

### **ASSEMBLY DRAWINGS**           (9)

There are 9 assembly drawings and one Primary Wiring Diagrams page separated from these instructions to help you with each step of the assembly.

## **MOD 102 GUITAR AMP KIT – BACKGROUND**

The MOD 102 Guitar Amp Kit was designed for anyone who is interested in building their own tube guitar amplifier head.

It is meant for practice amp volume (up to 5 Watts). It has an 8 ohm output impedance. (We recommend using it with a speaker cabinet that has an overall power handling of at least 10W). Use 16 AWG speaker cable to connect from the amplifier to your speaker cabinet.

The web-site [www.modkitsdiy.com](http://www.modkitsdiy.com) has been set up to help answer your questions after you have thoroughly read through the entire set of instructions.

## **TOOL LIST**

- Wire Strippers
- Needle Nose Pliers
- Cutting Pliers
- Desoldering Pump
- Solder (60/40 rosin core)
- Soldering Station
- Phillips Head Screwdrivers
- Slotted tip screwdrivers (3mm tip)
- Digital Multimeter (DMM)
- Alligator Clip Test Leads (to fit DMM)
- Channellock Pliers (or similar type)
- Miniature Round File (fine cut)

## PARTS LIST

Please see the parts list drawings for help with finding and identifying each part along with corresponding part numbers.

### **RESISTORS:**

<u>Description</u>		<u>Quantity</u>
100 $\Omega$	1W	1
200 $\Omega$	5W	1
1k $\Omega$	1W	1
1.5k $\Omega$	1/2W	2
5.6k $\Omega$	1/2W	1
6.8k $\Omega$	1/2W	1
22k $\Omega$	1W	1
100k $\Omega$	1/2W	3
220k $\Omega$	1/2W	1
220k $\Omega$	1W	1
1M $\Omega$	1/2W	1

### **TERMINAL STRIPS:**

<u>Description</u>	<u>Quantity</u>
5 lug terminal strip (1 <sup>st</sup> lug common)	3
5 lug terminal strip (3 <sup>rd</sup> lug common)	1
7 lug terminal strip (1 <sup>st</sup> & 7 <sup>th</sup> lug common)	1
2 lug terminal strip (2 <sup>nd</sup> lug common)	1

### **TRANSFORMERS:**

<u>Description</u>	<u>Quantity</u>
Power Transformer 369EX	1
Output Transformer P-T31	1

### **CAPACITORS:**

<u>Description</u>		<u>Quantity</u>
250pF	500V	1
.022 $\mu$ F	400V	1
.047 $\mu$ F	400V	1
.1 $\mu$ F	400V	1
22 $\mu$ F	50V	2
22 $\mu$ F	350V	2
47 $\mu$ F	350V	1
100 $\mu$ F	100V	1

### **HARDWARE:**

<u>Description</u>	<u>Quantity</u>
#8 self-tap screws	4
#6 screws	9
#6 hex nuts	9
#6 lock washers	2
#4 screws	4
#4 hex nut	4
#10 screws	4
#10 hex nuts	4
#10 lock washers	4

### **TUBES:**

<u>Description</u>	<u>Quantity</u>
12AX7/ECC83	1
6BQ5/EL84	1

### **MISCELLANEOUS PARTS:**

<u>Description</u>	<u>Quantity</u>
Solid state diode 1N4007	2
250k $\Omega$ audio pot	2
1M $\Omega$ audio pot	1
knobs	3
Input jack (switched)	1
output jack	1
9 pin miniature tube socket	2
preamp tube shield	1
EL84 tube retainer	1
Rubber Grommet (3/8" center)	4
Rubber Grommet (1/4" center)	1
violet jewel	1
Power switch (SPST)	1
1A fuse	1
Fuse holder	1
Light bulb	1
Lamp holder	1
Handle with mounting hardware	2
Rubber bumpers	4
Steel chassis box and cover	1/each
Labels	1 set
Green 20 AWG wire	4 feet
White 20 AWG wire	6 feet

Visit [www.modkitsdiy.com](http://www.modkitsdiy.com) if you have any problems when first turning on your amp for troubleshooting help. If you smell or see smoke, hear something pop, or the chassis becomes too hot to touch, turn off power and unplug immediately.

## SAFETY

Tube amps operate at high voltages that have the potential to injure and kill. Please remember the following when working on this project.

- Only work on the amp when you are wide awake and sober.
- Do not plug the amp in until you have gone through all of the instructions, checking and re-checking each step.
- Do not turn the amp on until you have connected it to a speaker cabinet.
- Be aware that tubes become very hot when the amp is on and can take up to 10 minutes to cool down after power is turned off.
- Work in a ventilated area when soldering.
- Always follow the one hand rule when working with an amp that is connected to power or may have voltage present. *(Any amp that has been plugged in at one time, may have high voltage present).*

**The one hand rule** (pictured below): is a safety precaution for working on an amp that is plugged in or could potentially have high voltages present. Using alligator clips with your DMM, clip the ground side to the chassis and use the other side to probe at various test points with one hand. *This prevents a fatal shock which can result from current passing through the heart.* (Many people even put their other hand in their pocket or behind their back).

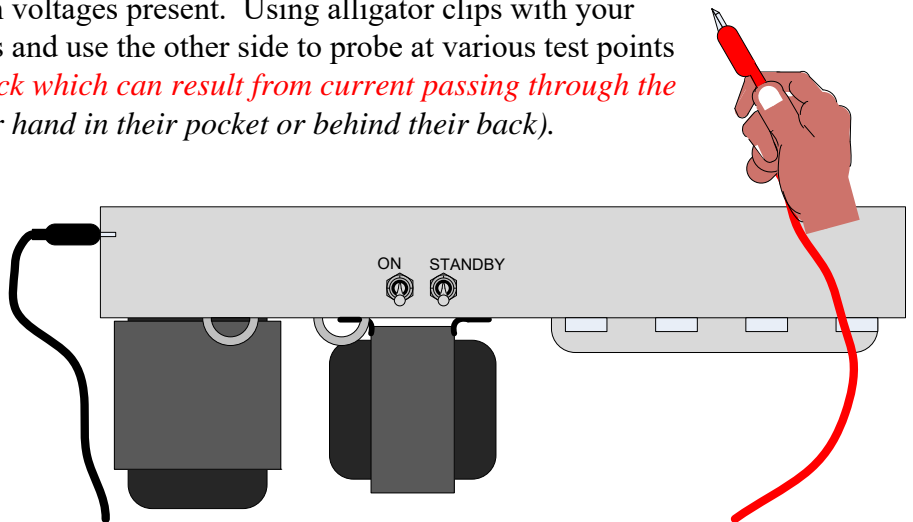

Always probe the amp for dangerous voltages at several test points before working on it, even if it has been turned off and unplugged for months.

### Test points include:

- Each positive end of polarized filter caps



## SOLDERING TIPS

It is important to make a good solder joint at each connection point. A cold solder joint is a connection that may look connected but is actually disconnected or intermittently connected. (A cold solder joint can keep your project from working.)

Follow these tips to make a good solder joint. *Take your time with each connection and make sure that all components are connected and will remain connected if your project is bumped or shaken.*

1. Bend the component lead or wire ending and wrap it around the connection point.
  - Make sure it is not too close to a neighboring component which could cause an unintended connection.
2. Wrap the component lead so that it can hold itself to the connection point.
3. Touch the soldering iron to both the component lead and the connection point allowing both to warm up just before applying the solder to them.
4. Be sure to adequately cover both component lead and connection point with melted solder.
  - Remove the soldering iron from your work and allow the solder joint to cool. (The solder joint should be shiny and smooth after solidifying.)
  - Cut off any excess wire or component leads with cutting pliers.
  - Clean the soldering iron's tip by wiping it across the wet sponge again after making the solder joint.

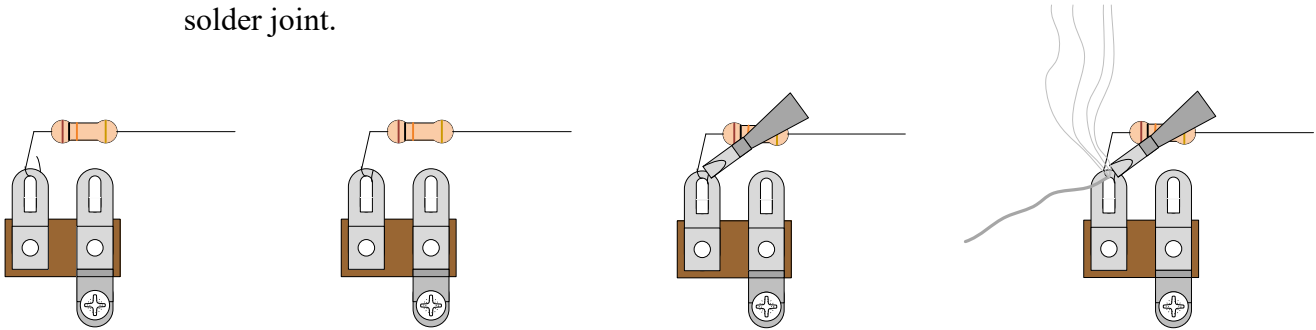

1. Bend the component lead and wrap it around the connection point.

2. Wrap the component lead so that it can hold itself to the connection point.

3. Heat up both component lead and connection point with the soldering iron.

4. Apply solder to both component lead and connection point.

### De-Soldering Tip

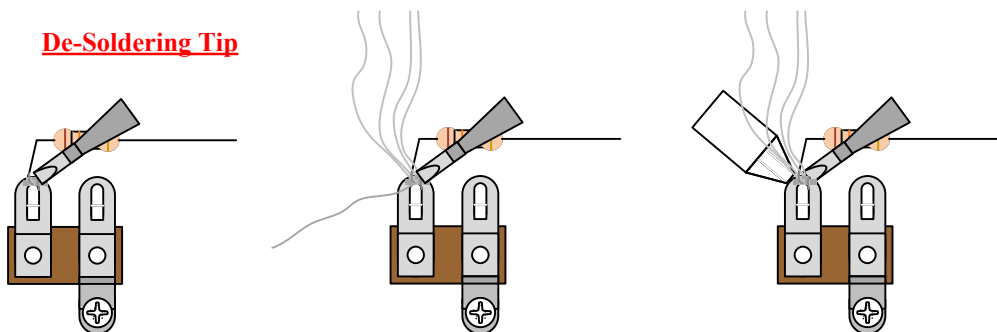

1. Heat up old solder joint with the soldering iron.

2. Apply fresh solder to mix in with old solder joint

3. Use a de-soldering tool to remove the old solder joint while it is heated.

## WIRING TIPS

- Because of the electro-magnetic properties of current traveling through a wire, there are wiring conventions used when making wire connections.

A) Twist the wires together where indicated in the instructions.

B) If two wire paths intersect, try to have them cross over each other as perpendicular as possible. (You should follow the path of the wires shown in the instructions).

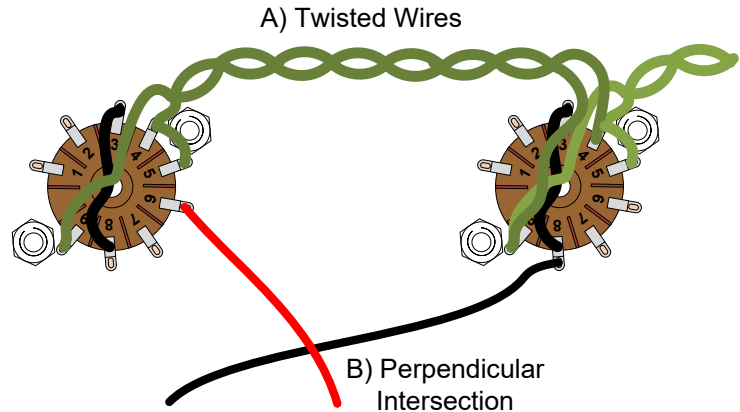

- Measure the wire by running it along its actual path (shown in the drawings) and then cutting it with your wire cutters at a length that will give it a little bit of slack after stripping off the insulation and soldering.

*It is important not to make the wires too long.*

- Be careful not to burn the insulation of nearby wires with the soldering iron.
- With the terminal strips used in this kit, you might want to connect some wires to the lower holes and components to the upper holes. (Doing this can make it easier to change components for modification).

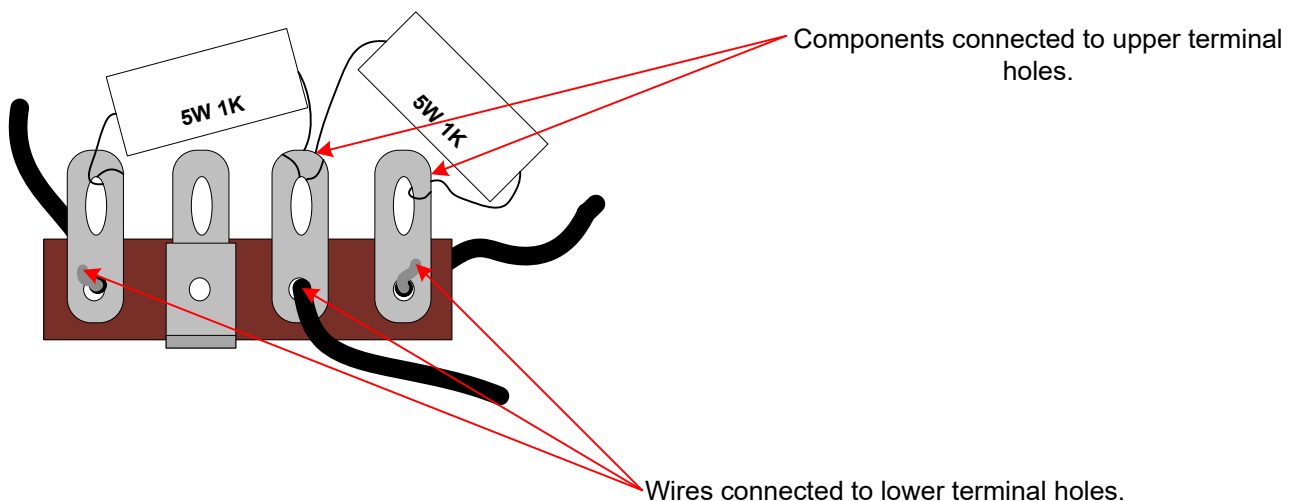

## HARDWARE FASTENING TIP

When fastening components with mounting hardware (screws, lock washers, and hex nuts), the lock washer and hex nuts should be fastened on the other side of the chassis from the head of the screw in the order pictured below.

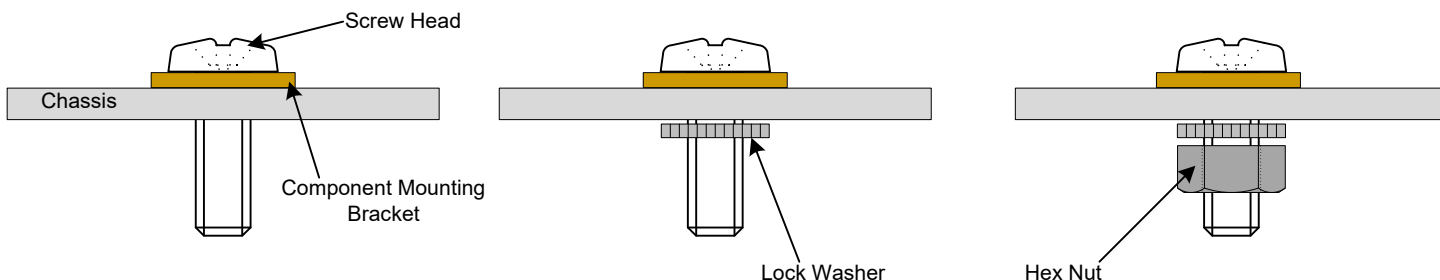

## STEP BY STEP ASSEMBLY

Please refer to the respective drawings for each section. *We recommend browsing over the instructions and looking at all drawings once before actually beginning to assemble the kit.*

### SECTION 1 – Mounting of Top Components

Please refer to **Drawings 1 – 3**.

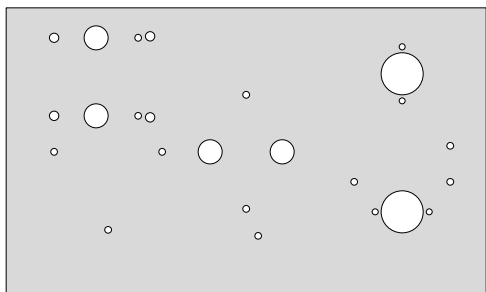

Find your chassis box. **Drawing 1** identifies the names of components that you will be mounting to the top of the chassis box.

#### Before you begin!

Use a fine cut miniature round file to carefully file away the paint coating only from the inside edge of each chassis hole.

*(The chassis provides the ground connection for many components so it is important that the inner edge of these holes are not insulated by the paint coating).*

#### Step 1 – Mount the Labels

Follow the label mounting instructions on page 17 and attach each label over its corresponding chassis hole.

#### Step 2 – Mount the rubber grommets with the 3/8" centers

**Drawing 2** shows where to mount these four rubber grommets. Squeeze the grommet into the hole and push it into place with your fingers.



#### Step 3 – Mount the 9 pin miniature tube socket for the 12AX7 with its tube shield

**Drawing 2** shows where to mount the 9 pin miniature socket “V1”. Make sure that pins 1 & 9 face the front of the chassis. Use #4 hardware and the tube shield to mount this socket.

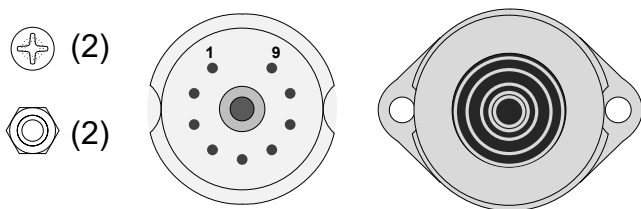

**Tip:** Because the tube shield mounting holes are very close to the socket edge, it may be easiest to fasten the first screw loosely and then the second screw by holding the hex nut (flat side to socket edge) against the chassis holes and then inserting the screw from the top of the chassis. Finish up by fastening both screws tightly.

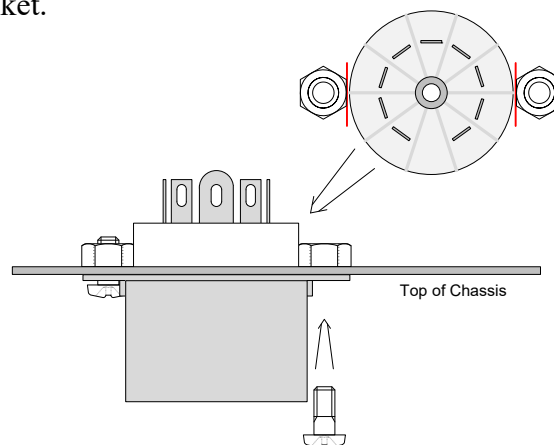





### Step 7 – Mount the Output Transformer (TR2)

**Drawing 3** shows where to mount the output transformer P-T31.

A) Hold the transformer up above the chassis and push the wires through their respective grommet holes as indicated on the drawing.

B) Place the transformer on the chassis so that the mounting holes line up with the transformer feet.

C) Use #6 mounting hardware to fasten the power transformer in place.



## SECTION 2 – Mounting of Front Components

Please refer to **Drawing 4**.

### Step 1 – Mount the Lamp Holder

**Drawing 4** shows where to mount the lamp holder. Be sure to mount it so that its solder lugs point towards the bottom opening of the chassis box. (Once the lamp holder is mounted you may screw in the bulb and then the jewel).

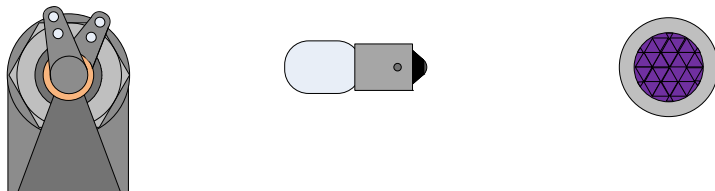

### Step 2 – Mount the Power Switch

**Drawing 4** shows where to mount the power switch. Be sure to mount the power switch with its solder lugs directed toward the chassis top.

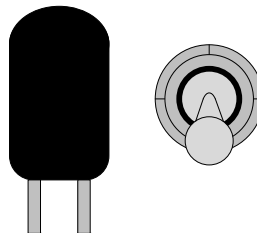

### Step 3 – Mount the Bass, Treble, and Volume Pots

**Drawing 4** shows where to mount the bass, treble, and volume pots. When they are mounted, turn their shafts all the way counter-clockwise. (Once you have done this, you can mount the knobs while pointing to “0” and tightening their set screws).

*It is good idea to use a contact cleaner on each pot before mounting.*

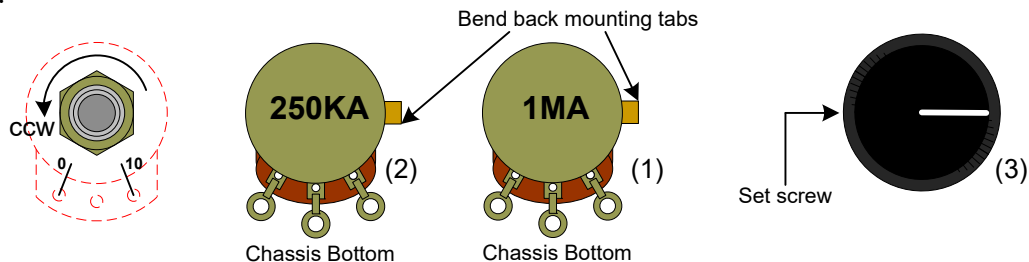

### Step 4 – Mount the Input Jack

**Drawing 4** shows where to mount the input jack.

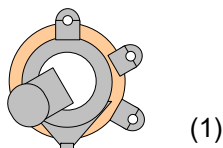

### SECTION 3 – Mounting of Rear Components

Please refer to **Drawing 4**.

#### Step 1 – Mount the Output Jack

**Drawing 4** shows where to mount the output jack.

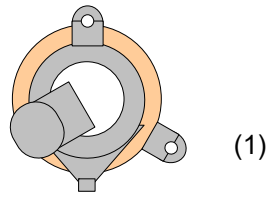

#### Step 2 – Mount the Fuse Holder

**Drawing 4** shows where to mount the Fuse holder. You can also insert the 1A fast blow fuse at this time.

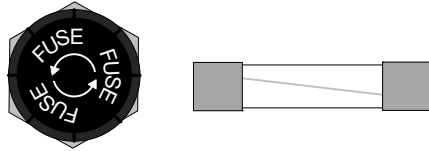

### SECTION 4 – Mounting Internal Terminal Strips and Passive Components

Please refer to **Drawings 5 & 6**.

#### Step 1 – Mount the Terminal Strips

**Drawing 5** shows what you should see when you flip the chassis box over so that you are looking inside and viewing from the rear side with the terminal strips in place. The terminal strips are labeled T1 – T6. (You will be mounting all 6 terminal strips in this step).

Use #6 hardware and **Drawing 5** to mount the 6 terminal strips in the same orientation as in the drawing.

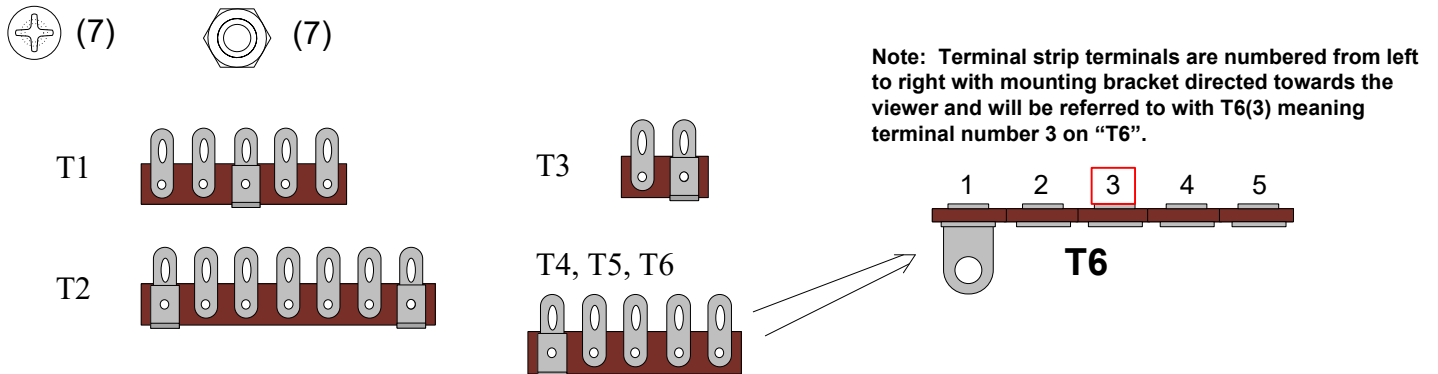

#### Step 2 – Solder Components to Their Terminal Strip Locations

Please see page 6 "Soldering Tips" if you are new to making solder connections.

**Drawing 6** shows each passive circuit component and its respective location on the terminal strip. Be sure to follow the same orientation of polarity as shown in the drawing for diodes and polarized electrolytic capacitors.

These instructions will walk you through the mounting of each component so that no components are missing. Unless noted otherwise, cut the component leads to a reasonable mounting length, wrap the leads around their connection points and solder. Be sure to leave room on each terminal for the mounting of future components. You can use **Drawings 6 to 9** to anticipate what other components and wires will be mounted to a particular location.

### Mount the three filter caps:

- 1) The 47  $\mu\text{F}$  cap is soldered with negative end to T1(5) and positive end to T2(5).
- 2) One 22  $\mu\text{F}$  (350V) cap is soldered with negative end to T1(1) and positive end to T2(2).
- 3) The other 22  $\mu\text{F}$  (350V) cap is soldered with negative end to T1(3) and positive end to T2(3).

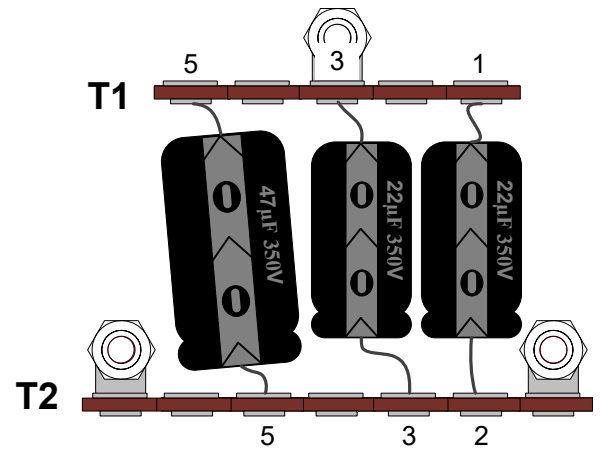

### Connect jumper wires to filter caps:

When connecting the wire, you want to strip about 1/4" of insulation off of each end to wrap around terminals.

- 1) Connect a short length of white wire (about 1.5") from T1(3) to T1(1).
- 2) Connect a short length of white wire (about 1.5") from T1(3) to T1(5).

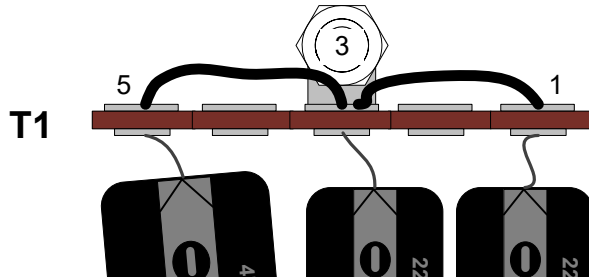

### Connect T2 components:

- 1) Connect the 22K 1W resistor from T2(2) to T2(3)
- 2) Connect the 100 $\Omega$  1W resistor from T2(3) to T2(5)
- 3) Connect the 220K 1W resistor from T2(5) to T2(7)
- 3) Connect one diode with the anode to T2(4) and cathode to T2(5).
- 3) Connect the other diode with the anode to T2(6) and cathode to T2(5).

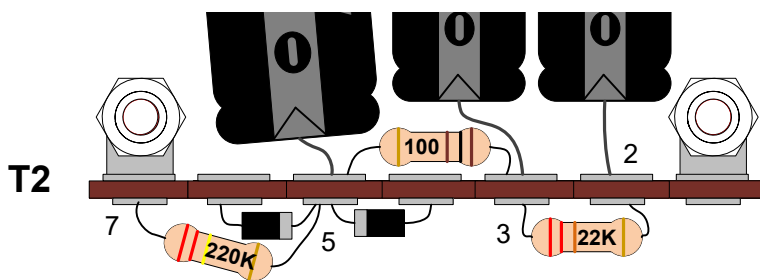
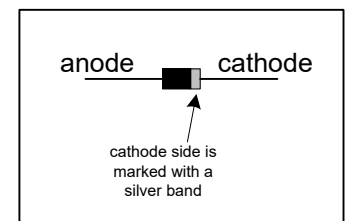

### Connect T3 components:

- 1) Connect the 6.8K resistor from T3(2) to the “bass” pot’s cold lug, but do not solder at the cold lug side, yet.
- 2) Connect the .047  $\mu$ F cap from T3(1) to the “bass” pot’s cold lug. Now solder at the “bass” pot’s cold lug side.
- 3) Connect the .1  $\mu$ F cap from T3(1) to the “bass” pot’s wiper lug, but do not solder at the wiper lug side, yet.
- 4) Connect a short length of white wire (2.25") from the “bass” pot’s wiper lug to the “treble” pot’s cold lug. Now solder at the “bass” pot’s wiper lug.
- 5) Connect a 100K resistor from T3(1) to T4(5).

### Connect T4 components:

- 1) Connect the 250 pF cap from T4(5) to the “treble” pot’s hot lug.
- 2) Connect a 100K resistor from T4(5) to T4(4).
- 3) Connect a 22  $\mu$ F 50V cap with negative end to T4(1) and positive end to T4(3).
- 4) Connect a 1.5K resistor from T4(1) to T4(3).
- 5) Connect a short length of white wire (2.25") from T4(5) to V1(1).
- 6) Connect a short length of white wire (2.25") from T4(3) to V1(3).

### Connect T5 components:

- 1) Connect a short length of white wire (2") from the T5(1) to T5(5). Use the lower terminal holes so that the wire does not obstruct your mounting of other components.
- 2) Connect a 22  $\mu$ F 50V cap with negative end to T5(5) and positive end to V1(8), but do not solder the connection at V1(8), yet.
- 3) Connect a 1.5K resistor from T5(5) to V1(8). Now solder the connection at V1(8).
- 4) Connect a 100K resistor from T5(2) to T5(3).
- 5) Connect a short length of white wire (1.5") from T5(3) to V1(6). Using the lower terminal hole of T5(3) might make things easier.
- 6) Connect the .022  $\mu$ F cap from T5(3) to T6(3).

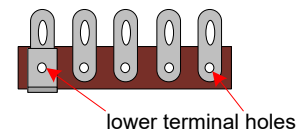

### Connect T6 components:

- 1) Connect the 1K 1W resistor from T6(5) to V2(9).
- 2) Connect the 5.6K resistor from T6(3) to V2(2).
- 3) Connect the 220K resistor from T6(3) to T6(1).

4) Connect the 200  $\Omega$  resistor from T6(1) to V2(3), but do not solder the connection at V2(3), yet.

5) Connect the 100  $\mu\text{F}$  100V cap with negative end to T6(1) and positive end to both V2(3) and V2(4), but do not solder the connection at V2(3) or V2(4), yet.

## SECTION 5 – Connect Front Mounted Components

Please refer to **Drawing 6**.

### **Connect Controls and Input Jack:**

1) Connect white wire (about 3.25") from V1(7) to the "volume" pot's wiper lug.

2) Connect white wire (about 2.75") from V1(2) to the "input" jack's signal lug, but do not solder the connection at the "input" jack, yet.

3) Connect white wire (about 2.5") from the "treble" pot's wiper lug to the "volume" pot's hot lug.

4) Connect white wire (about 2") from the "volume" pot's cold lug to the "input" jack's ground lug, but do not solder the connection at the "input" jack, yet.

5) Connect a 1M resistor from the "input" jack's signal lug to both its switch lug and ground lug. Add solder to all "input" jack lugs, now.

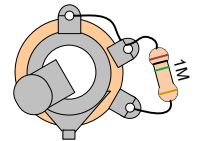
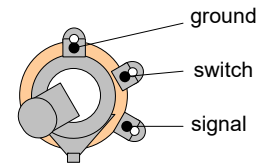
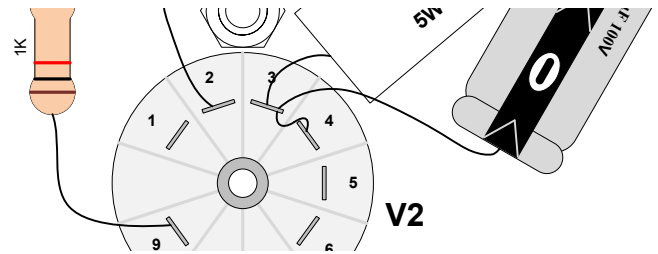

### **Connect to the Lamp Holder and Power Switch:**

1) Intertwine the two green wires from TR1 and connect their ends to the lower solder lug holes of the lamp holder. (It does not matter which green wire connects to which lug). *Be careful to leave the upper lug holes open for a future connection to the tube filaments.*

2) Connect the "N-Wire(s)" for your country from TR1 to the power switch as shown in **Drawing 6**. Allow for some slack before cutting the wire(s) to size. You may find it easier to connect by temporarily rotating the power switch for access to the solder lugs.

## SECTION 6 – Connect Rear Mounted Components

**Drawing 7** shows the inside of the chassis as viewed from the front looking at the rear.

### **Connect to the Output Jack and Fuse Holder:**

1) Intertwine the green and black wires from TR2 and connect their ends to the output jack with black to the signal lug and green to the ground lug.

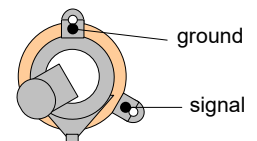

2) Connect the "L-Wire(s)" for your country from TR1 to the fuse holder's outer solder lug. Prop this lug slightly away from the fuse holder's plastic body and plan for a little slack before cutting.

3) If your country's mains voltage is 200V, 220V or 240V, you will need to intertwine and connect both "Center-Wires" for your country from TR1 to T1(2). *If your country's mains voltage is 100V, 110V or 120V, you should not have any wires to connect for this step.*

## **Insert and Connect the Power Cord:**

- 1) Install the grommet with ¼" center into the rear chassis hole.
- 2) Gently insert the power cord through this grommet hole until at least 18" (1.5 FT) are through. Tie a knot at the end of the cord so that 1" of black outside insulation extends past the knot. This knot will serve as a strain relief. Pull the knot as tight as possible by hand. Gently pull the cord back through the grommet from outside of the chassis until the knot is snug against the inside face of the grommet.
- 3) Connect the power cord's "Neutral (N)" (also known as "Common" or "Return") wire to the other lug on the power switch (see **Drawing 8**). You may find it easier to connect by temporarily rotating the power switch for access to the solder lugs.
- 4) Connect the power cord's "Line (L)" (also known as "Hot") wire to the central lug on the fuse holder.
- 5) Connect the power cord's "Earth (E)" (also known as "Ground") wire to T2(1).

## **SECTION 7 – Finish Connecting the Transformer and Power Supply Wires**

**Drawing 8** shows the inside chassis as viewed from the rear and looking at the front, again.

### **Connect the Power Transformer (TR1) Wires:**

- 1) Connect one of the TR1 red wires to T2(6).
- 2) Connect the other TR1 red wire to T2(4).
- 3) Connect the TR1 red/yellow wire to T2(1).

### **Connect the Output Transformer (TR2) Wires:**

- 1) Connect the TR2 red wire to T2(3).
- 2) Connect the TR2 blue wire to V2(7).

### **Connect the Tube Power Supply Wires:**

- 1) Connect white wire (about 5.5") from T2(2) to T4(4).
- 2) Connect white wire (about 3.5") from T4(4) to T6(5).
- 3) Connect white wire (about 2") from T6(5) to T5(2).

## **SECTION 8 – Connect the Tube Filament Wiring**

**Drawing 9** shows the inside chassis view with the filament wiring connected. Use the green wire for these connections and try to follow the wiring path in the drawing.

### **Connect the From Lamp Holder to V2:**

- 1) Cut two pieces of green wire (about 8.5" each) and connect one end of each to the lamp holder solder lugs.
- 2) Twist these two wires together and fasten, but do not solder, one wire to V2(4) and the other to V2(5).
- 3) Cut two more pieces of green wire (about 5.5" each) and connect one wire's end to V2(4) and the other wire's end to V2(5). Now solder all connections at V2(3), V2(4) and V2(5).
- 4) Twist these two wires together and connect one wire to V1(9) and the other wire to both V1(4) and V1(5).

### **SECTION 9 – Finishing Up**

#### **Double check your work:**

- 1) At this point, most people will feel anxious to start playing through their amp; however, it's important to always double check your work before applying power. Everyone makes mistakes and it's easy to forget things. Take some time now to thoroughly double check your work with **Drawings 7 & 9**. Make sure all solder connections are good and that polarized components are connected the right way.

#### **Attach the Chassis Cover and Rubber Bumpers:**

- 1) Use the four self-tap screws to fasten the chassis cover onto the amp.
- 2) Cut the four rubber bumpers apart from each other, remove their backing and stick them to the cover to serve as feet. A good place to put them would be near each self-tap screw.

#### **Put the tubes in their sockets:**

- 1) Flip the amp over and place the tubes into their respective sockets. The EL84 goes in V2 with the retainer holding it down.
- 2) The 12AX7 goes in the V1 socket with the tube shield holding it down.

#### **Step 7 – Turn It On and Play**

The MOD 102 has a single-ended (class A) output stage. There is no need to check the bias, just plug the amp in, connect the output to a proper 8 ohm load, let the tubes heat up for at least 10 seconds and it's ready to play.

Remember, that once the amp has been turned on, there will be high voltage (about 260 VDC) on the filter caps. If the amp has been assembled correctly, it takes about 2 ½ minutes for the voltage on these caps to drain to less than 1 VDC after the power is turned off.

Always use the one hand rule when working on an amp that has been plugged in (see page 5).

**Visit [www.modkitsdiy.com](http://www.modkitsdiy.com) if you have any problems when first turning on your amp for troubleshooting help. If you smell or see smoke, hear something pop, or the chassis becomes too hot to touch, turn off power and unplug immediately.**



## Label Mounting Instructions

The labels are meant to be placed over their respective chassis holes indicated below. There are four labels for the front panel and two labels for the rear panel.

### Cutting the Circle

Each circle on the labels is sectioned into eight pieces to help you cut out a nice circular shape for placement over its respective chassis hole.

1) Use a razor or x-acto knife to cut along each line first.

2) Then cut along the circumference, section by section, removing one sectional piece at a time.

